

Installation Instructions

Listed Certified for USA. and Canada
Certified to: ANSI 21.88b-2003, CSA 2.33b-2003, CGA 2.17-M91, CSA P.4.1-02

Model Number VFI25N, VFI25LP



“Gas Fired Vented Room Heater” Insert

Minimum Fireplace Opening Required - 24” Wide x 17 1/2” High x 16” Deep

**Read this complete manual before beginning installation.
These instructions must be kept with the unit for future reference.**

FOR YOUR SAFETY

Warning: Improper installation, adjustment, alteration, service or maintenance can cause property damage, personal injury or loss of life. Refer to this manual. Installation and service must be performed by a qualified installer, service agency or the gas supplier.

Do not store or use gasoline or other flammable vapors and liquids in the vicinity of this or any other appliance.

What To Do If You Smell Gas

Do not try to light any appliance.

Extinguish any open flame.

Do not touch any electrical switch.

Do not use any phone in your building.

Immediately call your gas supplier from a neighbour's phone.

If you can not reach your gas supplier, call the fire department.



KINGSMAN INDUSTRIES

A Division of R-Co. Inc.

2340 Logan Avenue

Winnipeg, Manitoba, Canada R2R 2V3

Ph: (204) 632-1962

PRE-INSTALLATION QUESTIONS and ANSWERS

Why does my fireplace or stove give off odour?

It is normal for your fireplace to give off some odour. This is due to the curing of the paint, adhesives, silicones and any undetected oil from the manufacturing process as well as the finishing materials used with the installations (e.g. marble, tile and the adhesives used to adhere this product to the walls can react with heat and cause odours).

It is recommended that you burn your gas fireplace or stove for a minimum of four hours at a time with the fan off after the curing of the paint has been completed. These odours can last upward to 40 hours of burn time, keep burning at a minimum of four hours per use until odours dissipate.

About curing of the paint

Your stove or fireplace has been painted with the highest quality silicone stove paint. This paint dries quickly in 15-20 minutes when first applied at the factory. However, due to the high temperature silicone components, the paint will cure when heat is applied to the appliance as it is first used.

The following information **applies to the curing process** to get the paint fully hard and durable.

Fire the appliance four successive times for 10 minutes each firing and a 5 minute cool down between each. Be aware during log and firebox paint curing that a white deposit may be developing on the inside of the glass doors. It is important to remove this white deposit from the glass doors with an appropriate cleaner to prevent build-up (such as Windex or a commercial fireplace glass cleaner).

- Babies, small children, pregnant women and pets should leave the area during the cure phase.
- Ventilate well, open doors and windows.
- Do not touch during curing.

Noise coming from the fireplace?

- Noise caused by metal expanding and contracting as it heats up and cools down, similar to the sound produced by a furnace or heating duct. This noise does not affect the operation or longevity of your fireplace.

Table of Contents

1. General	4
2. Unit Identification	4
3. Heat Output	4
4. Unpacking the Insert	4
5. Codes and Local Codes	5
6. Clearances	5
7. Electrical Connections	5
8. Gas Piping	6
9. Venting	6
10. Installation	8
Log Placement	9-10
11. Field Conversion for C30GEK	11
12. Combustion Air, Unit Operation & Checkout	12
14. Unit Adjustment	13
15. Maintenance	14
16. Surround and Brass Trim Assembly Instructions and Parts List	15
17. Surround Kit Parts List and Typical Venting Diagram	16-17
19. Wiring Diagram - SIT Valve	18
20. Accessory List	19-20
21. Replacement Parts	21-22
22. Lighting Instructions	23
Kingsman Industries Warranty	24

CAUTION: Under no circumstances should any solid fuels (wood, paper, cardboard, coal, etc.) be used in this appliance.

1. GENERAL

The following safety recommendations should be followed to ensure the safe and enjoyable operation of your gas fireplace.

1. Surface temperatures on the fireplace are high enough to cause severe burns and could possibly ignite clothing or furniture that is too close.
2. Adults and especially children should be warned to keep a safe distance from the fire place because of the potential of severe burns to skin and the possibility of ignition of clothing.
3. Young children should always be supervised when they are in the same room as the fire place. Even once the flame is turned off the fireplace will stay hot for quite some time.
4. This appliance should not be used as a drying rack for clothing, nor should Christmas stockings or decorations be hung in the area of it.
5. Due to high temperatures, the room heater should be located out of traffic and away from furniture and draperies.

NOTE: It is recommended that a Carbon Monoxide (CO) Detector be installed in or near bedrooms and on all levels of your home. Place a detector about 15 feet (4.5 meters) outside the room that houses your gas appliance.

2. UNIT IDENTIFICATION

Vented Fireplace Insert (VFI25N or VFI25LP). This unit is offered with variable speed fan and variable gas input.

3. HEAT OUTPUT

It must be remembered that both the units in this manual produce significant amounts of heat within a varying input range.

<u>VFI25N (NATURAL GAS)</u>		
(0- 4500ft) Input BTU/HR	Output BTU/HR	
	Fan "OFF"	Fan "ON HI"
Max 25,000	18,000	18,500
Min 17,000	12,240	12,580
Air Shutter	.093	Orifice #40

<u>VFI25LP (PROPANE)</u>		
(0- 4500ft) Input BTU/HR	Output BTU/HR	
	Fan "OFF"	Fan "ON HI"
Max 25,000	18,000	18,500
Min 17,000	12,240	12,580
Air Shutter	.375	Orifice # 52

MINIMUM FIREPLACE OPENING		
WIDTH	24"	(61 cm)
HEIGHT	17 1/2"	(44.5 cm)
DEPTH	16"	(40.7 cm)

4. UNPACKING THE INSERT

The unit has been packaged to ensure that the fireplace remains undamaged during regular handling.

It is important to inspect the packaging for signs of damage that may have affected the unit.

Included with the fireplace is the following:

- (1) fireplace insert
- (1) ceramic glass panel (fragile)
- (1) draft hood
- (1) installation instructions

With each insert the following must be purchased:

- (1) Log Set (4 pce) Cast or Fibre
- (1) Standard Surround Kit
- (1) Grill Kit

For a list of options please see page 18 and contact your local dealer.

5. CODES AND LOCAL CODES

1. Installation should be in accordance with applicable codes:
 (CANADA) - Fuel Burning Installation Code. Can./CGA-BI49.1 or .2
 (USA.) - National fuel gas ANSI -2223. 1
2. Electrical connections must be made in accordance with the applicable codes and the enclosed wiring diagram.
 (CANADA) - Canadian Electrical Code CSA-C22.1 part I
 (USA.) -National Electrical Code ANSI/NFPA no.70-1990
3. Local codes regarding wiring and installation of the unit must be observed.

6. CLEARANCES

This fireplace was designed for installation in a solid fuel fireplace that has been installed in accordance with National, Provincial/State and Local building codes and is constructed of non-combustible materials. DO NOT remove any refractory materials from any **masonry** solid fuel fireplace. For installation in **zero clearance** type listed solid fuel burning factory built fireplaces, it may be necessary to remove the damper plate and refractory liners. Removal of the smoke baffle is necessary in most cases.

Clearance from the front of the unit to a combustible floor is 0.15 metres (6 inches).

Clearance from adjacent side wall is 7 inches from side of unit.

•Minimum clearances from the top of the grill to a mantel and maximum mantel width are:

MANTEL WIDTH	HEIGHT ABOVE UPPER GRILL OPENING
--------------	----------------------------------

- | | |
|---------------|-------------|
| A 7”(17.8cm) | 13”(33.0cm) |
| B 6”(15.3cm) | 12”(30.5cm) |
| C 5”(12.7cm) | 11”(27.9cm) |

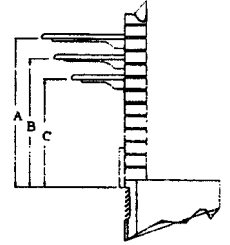

WARNING: The front of the fireplace gives off high temperatures that could ignite combustible material which is kept close to the front of the unit.

7. ELECTRICAL CONNECTIONS

The blower for the fireplace insert comes pre-wired from the factory all that is needed is to plug in to 120 volt supply.

Fan Temperature Sensor

The wiring harness has two wire ends that must be attached to the Temperature Sensor. The Temperature Sensor is mounted underneath the burner, attached by two screws securing the thermodisk to the bottom of the burner. (See page 18 for drawing assembly of SIT Wiring Diagram).

NOTE: MAKE SURE THE WIRE HARNESS IS ROUTED AGAINST THE SURROUND, NOT THE SIDE OF THE FIREPLACE.

Thermostat Connection and On/Off Switch

Millivolt Thermostat (optional but recommended). All controls are connected directly to the gas valve and the circuit is made between:

- SIT Valve TH and TP- TH, See Section 19

Grounding

When installed, the fireplace must be electrically grounded in accordance with local codes, or in the absence of local codes, with the National electrical codes.

8. GAS PIPING

All gas piping must be done in accordance with all applicable codes CAN./CGA-BI49.1 or .2 installation codes or ANSI -Z223.1 as well as local codes.

The appliance and its individual shutoff valve must be disconnected from the gas supply piping system during any pressure testing of that system at test pressures in excess of 1/2 psig (3.5 kPa).

The appliance must be isolated from the gas supply piping system by closing its individual manual shutoff valve during any pressure testing of the gas supply piping system at test pressures equal to or less than 1/2 psig (3.5 kPa).

The gas line to the fireplace insert should be of adequate size to minimise the pressure drop and should never be smaller than that supplied with the valve. A ground joint union should be used as close to the valve as possible to facilitate removal of the gas valve and burner base pan.

Check that the gas piping is not supported by the gas valve. A manual shut-off valve should be installed in the gas line, inside the fireplace. All piping joints must be tight and an approved non-hardening sealing compound shall be used (one which is suitable for future service).

For the state of Massachusetts a **T-handle gas shut-off valve** must be used on a gas appliance. This T-handle gas shut-off valve must be listed and approved by the state of Massachusetts. This is in reference to the state of Massachusetts state code CMR238.

CAUTION: Never use a flame to check for leaks - use an approved leak test solution.

9. VENTING

Before any vent liner is run through a masonry chimney or other approved venting system the **chimney must be inspected, cleaned and rep aired** if necessary . A chimney which was used for a solid fuel fireplace must be professionally cleaned in order to reduce corrosion of the vent and other possible safety hazards.

VENT LENGTH (4" Diameter Vent)

	<u>Vertical (rise)</u>	<u>Horizontal (run)</u>
Min	10 ft - 3.1m	0 ft - 0.0 m
Max	50 ft - 16.2 m	2 ft - 0.6 m

This fireplace insert is approved for use with a 4" inch diameter.

All venting lining products must be approved and installed according to the vent manufactures installation instructions. All vent liners must terminate in a rain cap to prevent debris and rain from entering the vent and possibly damaging the appliance or creating an unsafe condition. The area between the existing chimney and liner must be capped off for the same reasons as above and to reduce the chances of venting problems and corrosion of the vent.

This heater must be properly connected to a venting system. This heater is equipped with a vent safety spill switch shutoff system.

WARNING

Operation of this heater when not connected to a properly installed and maintained venting system or tampering with the vent safety spill switch shutoff system can result in carbon monoxide (CO) poisoning and possible death.

It is strongly recommended that the area between the damper and the liner be blocked to prevent the possibility of flue products entering the area between the chimney and the vent liner.

If this fireplace insert is to be used to replace an existing fireplace insert the existing vent liner must be of the proper size and if so it must be inspected for obstructions, damage and/or corrosion. Replacement must be done as necessary .

NOTE: Follow vent manufacturer's installation instructions.

When installing the venting please take note of the following:

1. A masonry chimney or other approved venting system must be clean and inspected for any damage which might make it unsafe. Chimney must be constructed of non combustible material.
2. Any chimney clean-outs must be tight fitting as to minimize air leaks into the chimney.
3. Any flue damper must be blocked open or removed to provide a minimum opening of 13 square inches and must not distort the liner.
4. The liner is to be inserted from the top of the chimney and through the damper opening.
5. The draft hood is to be removed from the fireplace insert and attached to the liner using (3) sheet metal screws and a clamp (**See Figure 1**). It may not be necessary to remove the draft hood if there is sufficient space in the solid fuel fireplace to attach the liner with the draft hood in place 19" is required.
6. If the lintel is wider than 12" (305mm) then the height of the solid fuel fireplace must be at least 25" (63.5 cm) to allow for an offset elbow. (**See Figure 2**). **If providing an offset, do not collapse the flex pipe. This will restrict the vent and cause a red flame which will produce soot on glass.**
7. If however the draft hood must be removed then it must first be attached to the liner using three (3) sheet metal screws and a clamp. The fireplace insert can then be slid into place and the draft hood should be located so that the screw on the locating bracket mates with the hole on the top centre front of the insert. The locating bracket should be pulled as far forward as it will go and be bolted into place (a flashlight should be used to confirm that the draft hood is flat on the top of the unit. Once the draft hood is in place a long screw driver or piece of rod must be used to rotate the locking brackets so that the lock over top the flanges on the side of the draft hood. (**See Figure 3**)

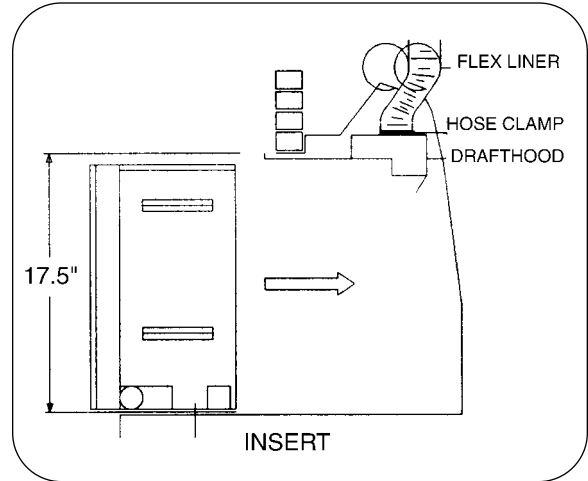

(Figure 1)

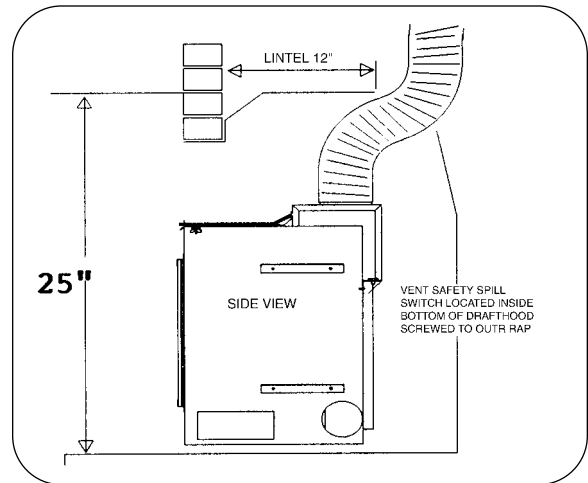

(Figure 2)

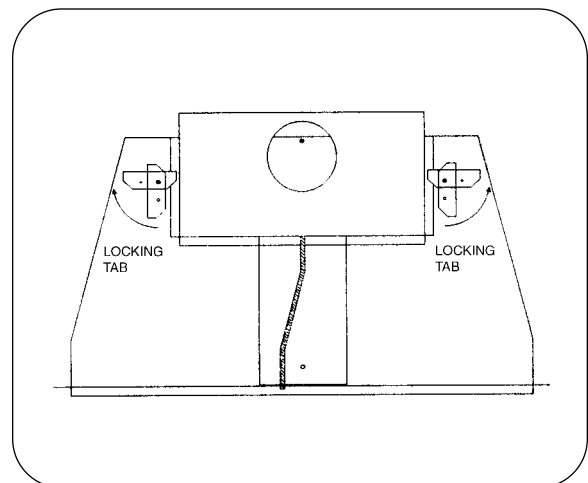

(Figure 3)

10. INSTALLATION

NOTE: INSTALLATION AND REPAIR SHOULD BE PERFORMED BY A QUALIFIED SERVICE PERSON. THE APPLIANCE SHOULD BE INSPECTED BEFORE USE AND AT LEAST ANNUALLY BY A PROFESSIONAL SERVICE PERSON. MORE FREQUENT CLEANING MAY BE REQUIRED DUE TO EXCESSIVE LINT FROM CARPETING, ETC. IT IS IMPERATIVE THAT THE CONTROL COMPARTMENT, BURNING AND CIRCULATING AIR PASSAGEWAYS OF THE APPLIANCE BE KEPT CLEAN.

Install the fireplace insert in the following order:

1. Make sure that the insert will fit into the fire place. Most Zero Clearance wood fireplaces will need to be modified. The refractory can be removed if necessary and the front of the appliance can be altered to allow the insert to fit into the cavity. Holes will have to be made in the firebox for the entry of gas and electrical but the chamber must not be altered beyond this.
2. Clean and inspect chimney.
3. Plan layout of gas line.
4. Plan layout of electrical.
5. Install the chimney liner as instructed in SECTION 9.
6. Clean out and vacuum the solid fuel fireplace. **Make sure that the fireplace is completely cool and has not been used for a few days.**
7. Make sure that the solid fuel fireplace base is level and if not make any necessary adjustments.
8. Slide unit into place attaching draft hood and or chimney liner as required.
9. Hook up gas line.
10. Hook up electrical.
11. Remove glass by removing two screws behind upper grill and lifting door off bottom door retainer (glass is very fragile).

12. Log Installation:

- Remove logs from carton (4) and inspect.
- Install as per Log Placement set up.
- Purge lines and test pilot operation.

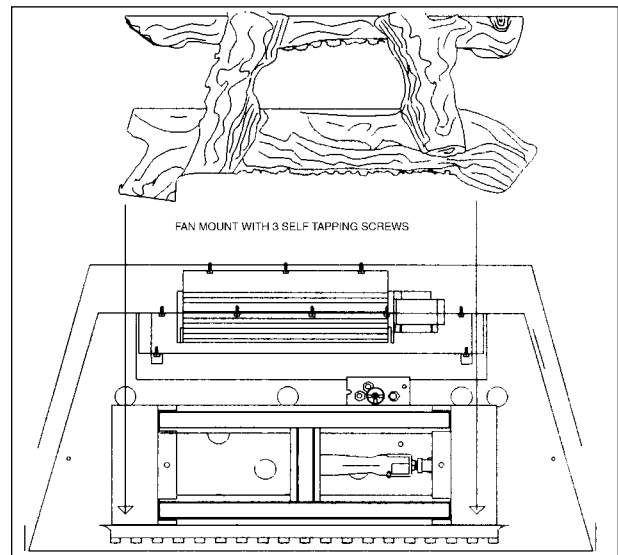

13. Ember Kit Instructions:

- Spread supplied rock evenly on the bottom of the fireplace around the log set (**DO NOT PLACE ROCK ON BURNERS**), next tear ember wool into small thin pieces and place evenly over front burner .
14. Re-install the glass door.
 15. Check for correct operation (See SECTION 12)
 16. Install Surround and Grills as per instructions.

NOTE: DO NOT BLOCK THE SIDES OR TOP OF THE APPLIANCE AS THIS WILL AFFECT THE PROPER AND SAFE OPERATION OF THE UNIT.

LOGC5 OR LOGF5 PLACEMENT GUIDELINES



C5 or F5 Parts

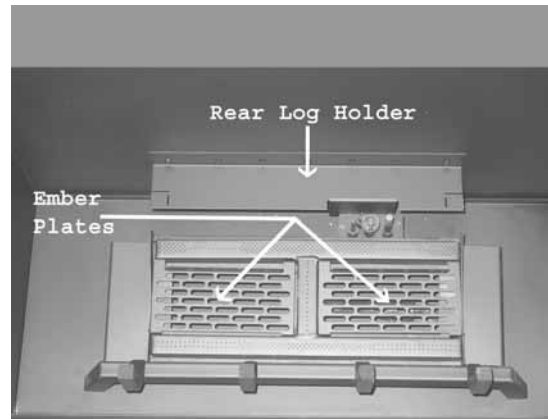

Burner



Step 1: Break ember wool into thumbnail size pieces. Place glowing embers evenly on to the front burner tube as shown.

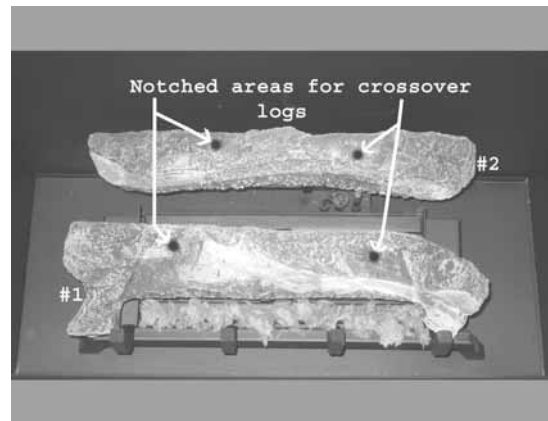

Step 2: Place Log #1 on burner as shown and pull forward to the grate bars. Place log #2 on rear log holder and center it.

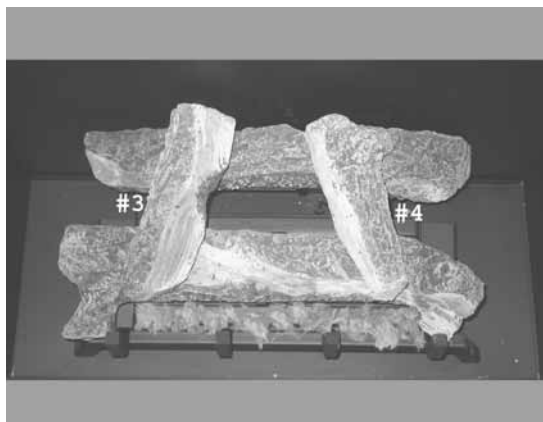

Step 3: Place Log #3 onto the notched areas as shown. Place Log #4 onto the notched areas as shown. (Refer to step 2 for notched area locations).



Step 4: Place lava rock around the sides and the front of the burner as shown. Sprinkle vermiculite over top of the lava rock as shown. (Do not place lava rock or vermiculite on the burner tube areas).

LOGC6 PLACEMENT GUIDELINES



Log C6 Parts List

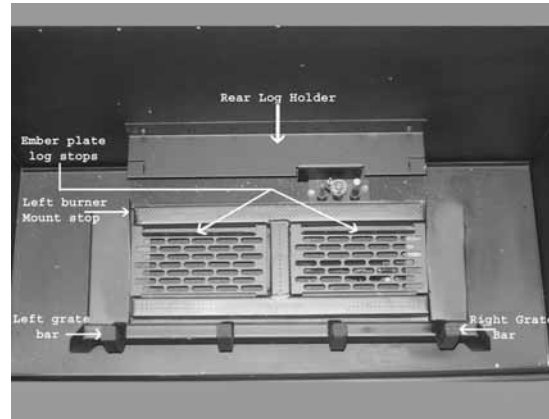

Burner

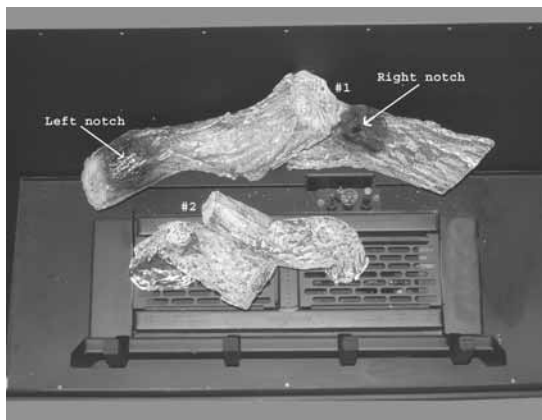

Step 1: Place Log #1 on rear log holder, center it, and push back. Place Log #2 against the left burner mount and back against the ember plate log stop as shown. (Log must not impinge on main flame pattern).

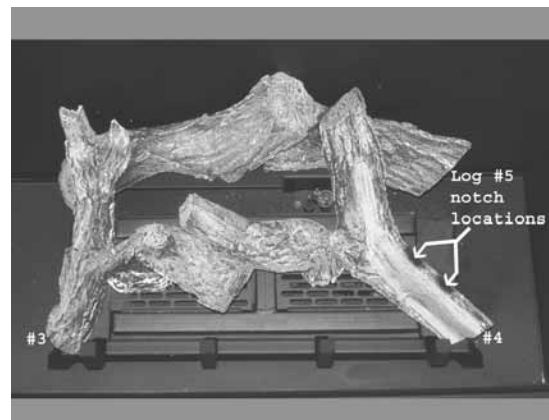

Step 2: Place Log #3 onto the left notch of Log #1 and against the left grate bar as shown. Place Log #4 onto the right notch of Log #1 and against the right grate bar as shown.

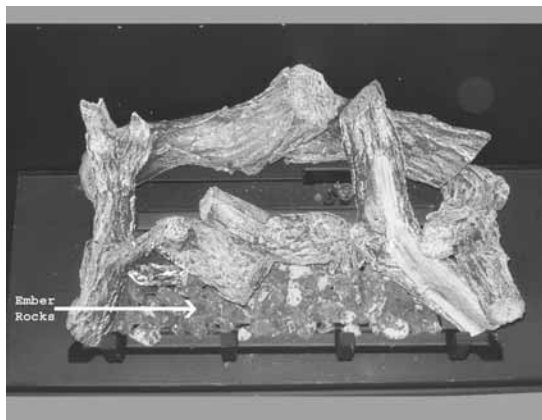

Step 3: Place Log #5 on the notched locations of Log #4. (Refer to step 2 for Log #5 notch locations). Fill the exposed areas of the ember plates and front burner tube with ember rocks. (Do not place ember rocks on rear burner tube).

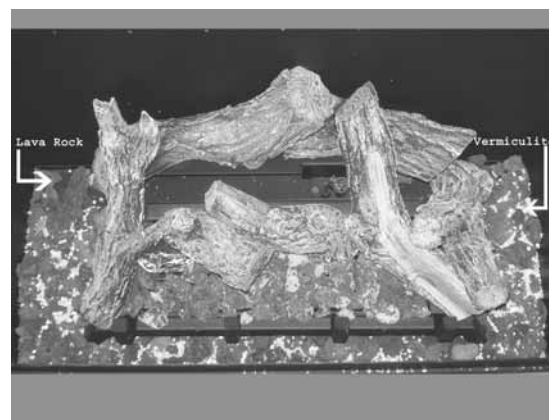

Step 4: Place lava rock around the sides and front of the burner. Sprinkle the vermiculite over top of the lava rock. (Do not place lava rock and vermiculite on burner or ember plates).

Field Conversion for ZDV6000 - VFI25 - VFI30

C6GEK: ZDV6000 Conversion

- 2 - Ember Plates
- 1 - Ember Plate Bridge
- 1 - Grate Assembly with 5/8" Bars
- 4 - 1/2" x 8-18 DT Screws

C30GEK: VFI25 & VFI30 Conversion

- 2 - Ember Plates
- 1 - Ember Plate Bridge
- 1 - Grate Assembly with 1/2" Bars
- 2 - 1/2" x 8-18 DT Screws

Tools Required: Drill, 1/8" Drill Bit, 1/4" Nut Driver Bit

Step 1: Remove existing grate bar by bending bar slightly forward and drill out rivets.

Step 2: Seal rivet holes with two supplied screws. (ZDV6000 ONLY)

Step 3: Center legs of Grate Bar on either side of burner support and fasten with supplied self drilling Screws. (Ref: 1)

Step 4: Place Ember Plates between burner tubes right and left of Burner.

NOTE: Raised flange of Ember Plates must be to back of Burner.

Step 5: Slide Ember Plate Bridge between Ember Plates. (Ref: 2)

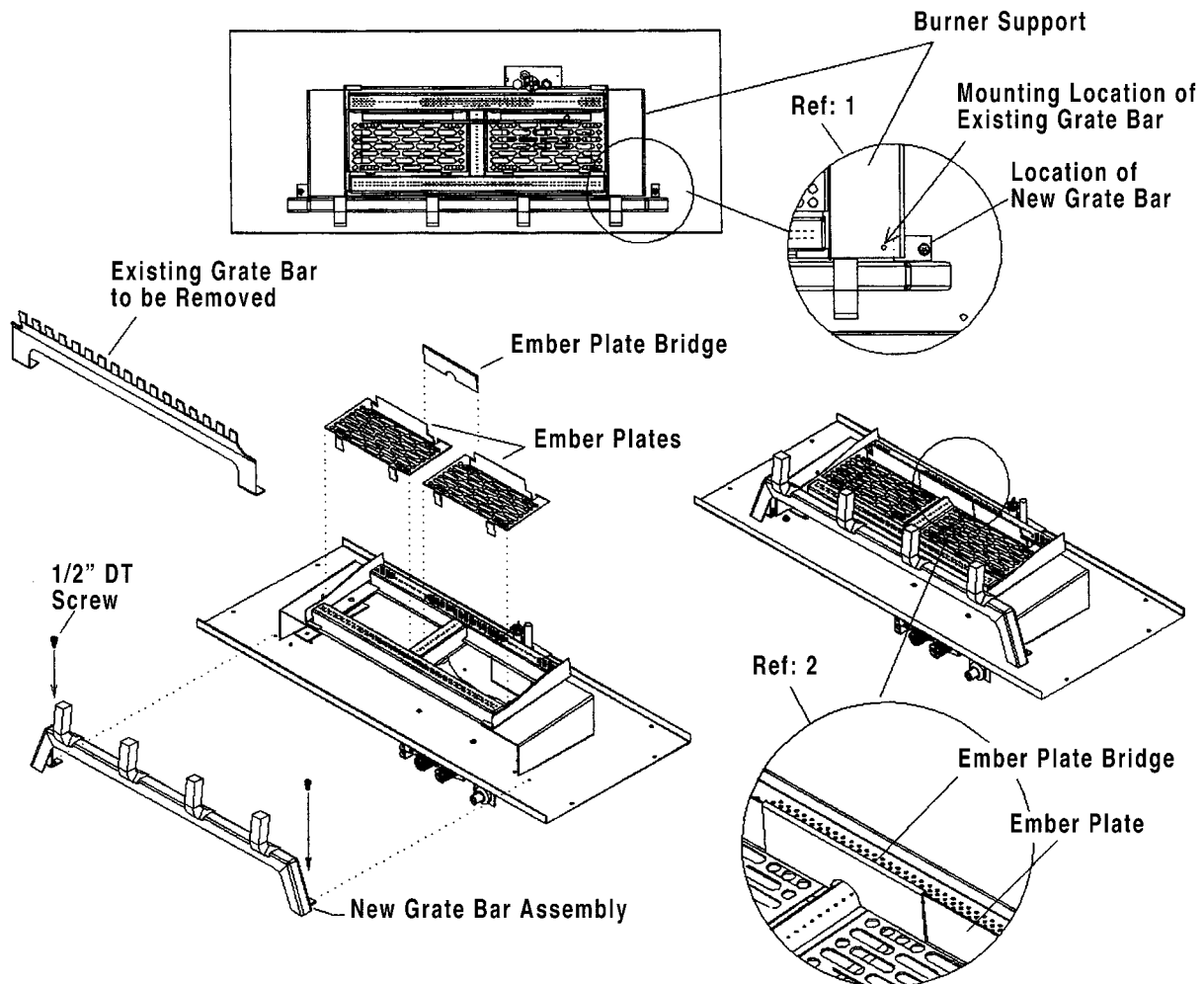

11. COMBUSTION AIR

Indoor combustion air must conform to the requirements of the applicable code: Canada Installation Code CAN/CGA-B149.1 or .2 (USA.) National Fuel Gas Code ANSI-Z223.1

In homes of normal construction, sufficient combustion air can usually be obtained by air infiltration. The fireplace insert must be installed in area that is free of excessive dust and dirt and where ventilation is sufficient to provide proper combustion of gas, proper venting and the maintenance of safe operating temperatures. When infiltration does not provide adequate air for combustion, outside air shall be introduced as specified in the installation codes.

The draft hood must be installed so as to be in the same atmospheric pressure zone as the combustion air inlet to the appliance.

To check if there is adequate air for combustion perform the following procedure: (See Figure 5)

1. Close all windows and doors.
2. Turn all exhaust fans on high.
3. Turn on fireplace insert.
4. To check for proper draft action a draft meter with a minimum graduation of 0.01 inches of water column is required. The meter is to be attached to the 1/4 inch aluminium tube originating in the draft hood using high temperature silicone (tubing should not be allowed to contact glass and unit should be allowed to run for a minimum of 10 minutes; area of sensing tube will become quite hot).

A minimum draft pressure of .02 inches of water column is required to ensure that there is no spillage at the draft diverter. This number was arrived at through testing under various severe conditions, actual vent pressures under normal conditions will be much higher. A draft pressure under .02 will indicate either a blocked vent, down draft, adverse house de-pressurization or improper venting.

- If there is not the proper draft then provide outside air as instructed by the applicable code.

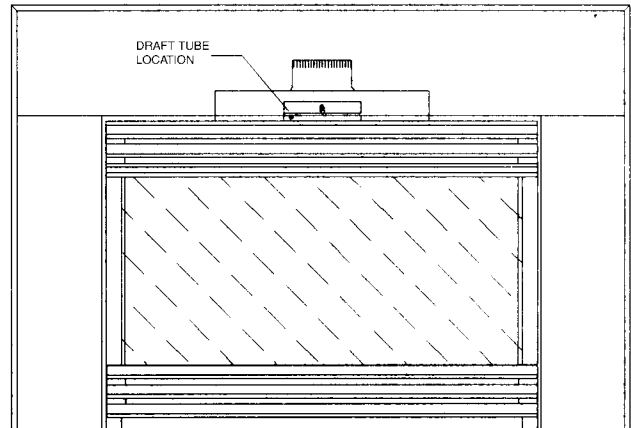

(Figure 5)

NOTE: DO NOT OBSTRUCT FLOW TO THE FRONT OF THE FIREPLACE AS THIS COULD AFFECT COMBUSTION AND BE A FIRE HAZARD. FAILURE TO DO SO COULD RESULT IN PROPERTY DAMAGE, INJURY AND/OR LOSS OF LIFE.

12. UNIT OPERATION & CHECK-OUT

Before trying to light the unit for the first time it is advisable to purge the gas. Once the gas line is purged it is best to wait a few minutes with a few open windows before trying to light the fireplace. For detailed lighting instructions see page 23.

Start-up Instructions:

1. Turn wall switch (or thermostat) to the off position.
2. Turn gas valve to "PILOT" and depress.
3. Press the red spark button repeatedly until a steady pilot flame is present.
4. Keep the "PILOT" position on the gas valve depressed for approximately 45 seconds.
5. Turn gas valve to the on position.

Sequence of operation:

1. Turn On/Off switch (or thermostat) to the on (call for heat) position.
2. Main burner lights.
3. If blower variable speed switch is in the “On” position then the blower will turn on automatically once the unit is hot enough.
4. Once the On/Off switch is turned off (or thermostat is satisfied) then the flame will extinguish.
5. Blower will keep on running until the fire place has cooled down.

Shut Down Instructions:

1. Turn On/Off switch (or thermostat) to the off position.
2. Depress gas valve and turn to “OFF” position.

13. CHECK-OUT

Once installed, the unit should be operated at least three (3) times to ensure that all is in working order. NOTE: MANUFACTURING OILS AND PAINT WILL SMOKE DURING INITIAL FIRING OF APPLIANCE. OPEN WINDOWS FOR VENTILATION.

14. UNIT ADJUSTMENT

BEFORE LEAVING, THE INSTALLER SHOULD MAKE THE FOLLOWING CHECKS:

(a) BTU/INPUT / GAS PRESSURE

The fireplace input is marked on the Rating Plate. The gas valve comes factory pre-set to the proper rated pressure and adjustment should not be necessary . If there is any question of input then it may be necessary to check manifold pressure.

Manifold pressure on the S.I.T. Nova valve can be measured by loosening the slotted pressure taps on the front bottom left of the valve. (‘E’ Inlet Pressure, and ‘A’ Manifold Pressure) and connecting a manometer .

Pressure ranges are as listed below:

<u>Gas Supply Pressure (inches w.c.)</u>			
	Min	Normal	Max
Natural Gas	4.5	7.0	9.0
L.P. (propane)	10.8	11.0	12.0

<u>Manifold Pressure (inches w .c.)</u>		
	Normal(HI)	(LOW)
Natural Gas	3.5	1.6
L.P. (Propane)	10.0	6.3

The unit as shipped is equipped for operation for 0 to 4500 ft.

(b) MAIN BURNER / PILOT

The **pilot flame** size is factory set. The pilot flame should be at least 1.5 inches (4 cm) long. The flame should be impinging on the pilot generator . Pilot size can be adjusted through the pilot adjust screw. If the pilot flame is too small and can not be adjusted through the pilot adjust screw then there is the possibility of dirt in the pilot orifice in which case the pilot orifice should be cleaned or replaced.

The **main burner** should be allowed to operate for 15 to 20 minutes before making any adjustment to the unit.

The **air shutter** should never be closed all the way. For **Natural Gas and Liquid Propane** it is recommended that the air shutter be set to Factory Specifications. (See Page 4) .

If there is **too much primary air** then the flame will be very blue with yellow tips and smaller flame height.

If there is **too little primary air** then the flame will be yellow with orange/red tips on the back flames with dark sooty elongated tips. In this condition the glass and logs could show signs of soot accumulation within 10 to 20 minutes.

NOTE: With a properly burning flame there will still be a certain level of sooting. It may be necessary to clean the glass up to 3 times during a cold season. The amount of cleaning required depends on the amount that the fire place is used.

15. MAINTENANCE

CAUTION: Label all wires prior to disconnection when servicing controls. Wiring errors can cause improper and dangerous operation. Verify proper operation after servlcmg.

WARNING: INSURE THAT POWER IS TURNED OFF TO THE FIREPLACE BEFORE SERVICING.

(a) Blower

This motor has been factory oiled and under normal operating conditions should not require oiling.

Replacement of Blower

Remove glass (two screws behind upper grill), and remove logs. Blower access panel is visible after rear log is removed. Remove the screws (five on top, one on each side) and lift from tabs, blower is then assessable for servicing. Before re-installing blower access panel, apply a bead of sealant Millpac to the bottom edge of panel, (this is to assure blower does not interfere with combustion). and than secure with screws.

(b) Burner/Pilot

The burner should be periodically cleaned by removing any ember material and wiping off and vacuuming the burner pan. At this time it is also recommended to check the burner for any signs of corrosion which might impair its operation and replace it if necessary.

The pilot should also be checked for signs of proper operation and flame. *If replacement of*

pilot, generator, thermocouple is necessary replace from top and bottom of firebox bottom.

(Reference lower diagram Page 18)

(c) Logs

CAUTION: The logs can stay hot for several hours after the fireplace is shut off. Serious burns could result. It is recommended that the fireplace be turned off for several hours before cleaning is attempted.

DO NOT wash the logs if they have any accumulation of soot on them. Washing the logs in any sort of solution will just cause the soot to become imbedded in the logs surface.

The best way to clean the logs is to blow off the soot using compressed air at high velocity. It is also effective to use a clean soft brush in the area of soot accumulation. Vacuuming the log with a soft brush will also work but do not forget to carefully wash the brush before using it on anything else. If at all possible clean the logs outside the home away from areas you do not wish the soot to mark.

(d) Firebox and Heat Exchanger

To clean the firebox and heat exchanger use a vacuum. For the firebox it is recommended to use a soft brush on the end of the vacuum as not to damage any painted surfaces. The heat exchanger may be more difficult to clean but can still be cleaned with the combination of a small brush and the vacuum.

(e) Glass

It will be necessary to clean the glass periodically. During start-up it is normal for condensation to form on the glass and cause dirt, soot, lint etc., to adhere to the inner surface of the glass. There also will be a film deposited on the glass during the initial use of the fireplace due to initial curing of the paint. It is recommended that the glass be cleaned with a non-abrasive household cleaner and warm water.

Be sure to rinse and dry the glass well as not to leave any marks. It will be necessary to clean the glass up to 3 times a season depending on use of the fireplace.

(f) Brass Trim and Surround

All Brass and Painted surfaces should only be wiped off with a soft non abrasive damp cloth (a mild dish soap can be used if necessary).

DO NOT use brass or other metal polishes, glass cleaners or any other abrasive cleaners as this will mark and damage brass or painted surfaces.

(g) Venting

Venting should be inspected yearly by a qualified service technician and replaced if necessary . Draft action should be tested for as outlined in Section 11 to conform that conditions in the house have not changed or that the vent has not become blocked or damaged.

(h) Valve and Burner Replacement

For valve replacement it is recommended that the burner assembly be removed, this is done by removing two 1/4" hex screws on the left and right side of the firebox and lifting the complete burner assembly from the unit and replacing defective component and re-installing. Check for gas leaks after replacing burner assembly.

WARNING

Electrical Grounding Instructions

This appliance is equipped with a three prong (grounding) plug for your protection against shock hazard and should be plugged directly into a properly grounded three-prong receptacle. Do not cut or remove the grounding prong from this

WARNING

The appliance area must be kept clear and free from combustible materials, gasoline and other flammable vapours and liquids.

WARNING

Do not use this heater if any part has been under water. Immediately call a qualified service technician to inspect the heater and to replace any part of the control system and any gas control which has been under water .

16. Surround and Brass Trim Assembly Instructions (Three Piece Surround & Picture Frame)

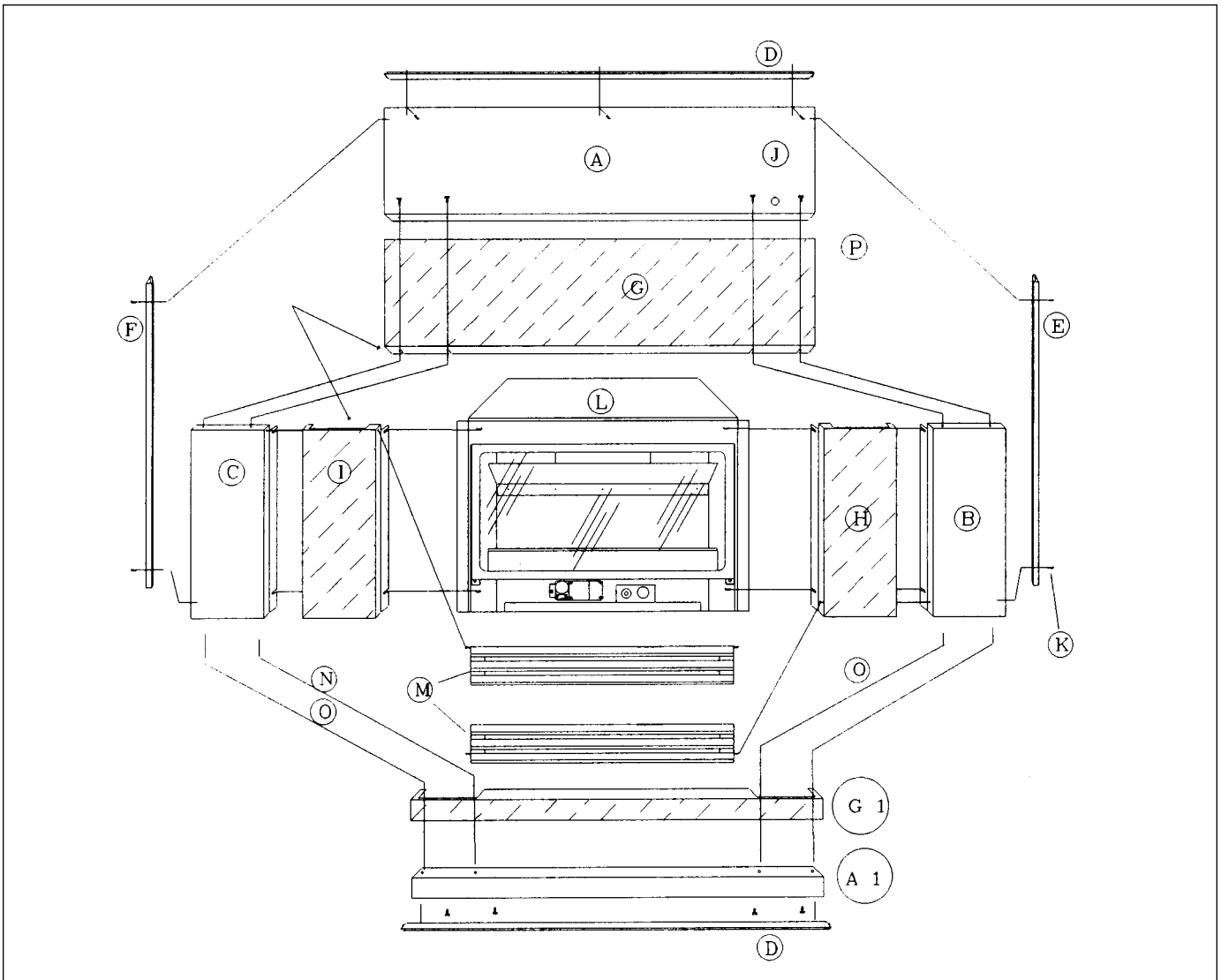

Before attaching surround assembly, check operation of insert and installation of draft hood and chimney liner.

To assemble surround attach panel (A), (B), (C), and (A1) if Picture Frame was purchased) with bolts (10/24) and star lock nuts, if optional brass panel kit was purchased install at this time over the surround kit and tighten the bolts to secure all panels.

All brass trims (D), (E), and (F) are installed with 5/16 x 6/32 self tapping screws, attach part (D), (E) and (F) to outer edge of surround. Then place On/Off switch into slot (upper right corner) after trim has been attached to surround. Route wires through 3/4" grommet hole, down right side of surround into right side of insert. A hole is provided in blower intake box to route wires over to the valve, attach at TP and TP- TH. **(Refer to Wiring Diagram Section 19)**

17. SURROUND KIT PARTS LIST

<u>Ref. No.</u>	<u>Surround Small Part Number</u>	<u>Surround Large Part Number</u>	<u>Picture Frame Part Number</u>	<u>Description</u>	<u>Quantity</u>
A	3000-301	3000-311	3000-320	Top Panel	1
B	3000-302	3000-312	3000-321	Side Panel Left	1
C	3000-303	3000-313	3000-322	Top Panel Right	1
Al	n/a	n/a	3000-323	Bottom Panel	1
D	3000-304	3000-314	3000-328	Brass Trim Top	1
E	3000-305	3000-315	3000-330	Brass Trim Left	1
F	3000-306	3000-316	3000-329	Brass Trim Right	1
G	3000-307	3000-317	3000-324	Brass Panel Top	1
Gl	n/a	n/a	3000-327	Brass Panel Bottom	1
H	3000-308	3000-318	3000-326	Brass Panel Left	1
I	3000-309	3000-319	3000-325	Brass Panel Right	1
J	10/24 x 1/2" Screw w/Nuts		(4) - Three Piece Surround	(8) - Picture Frame Surround	
K	5/16 x 6/32" Black Screw		(6) - Three Piece Surround	(8) - Picture Frame Surround	
L				(Attached Points on Insert)	
M	(V120GAB, V120GBL, V120GPB)			Grill Kit	

18. TYPICAL VENTING DIAGRAM

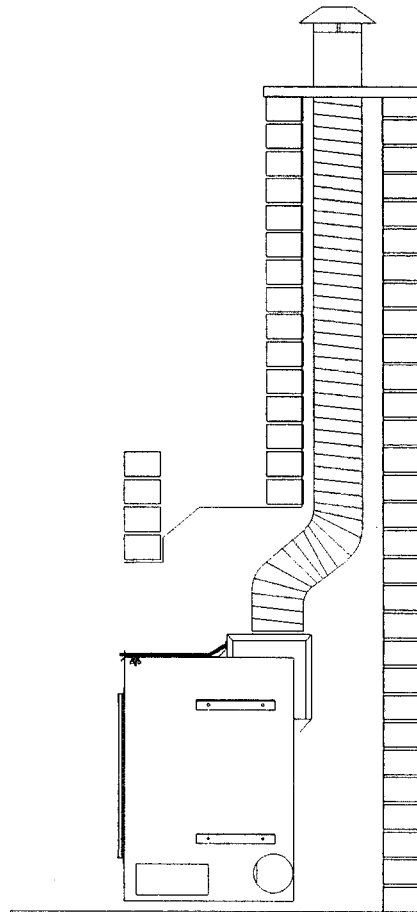

19. WIRING DIAGRAM - FOR SIT VALVE SYSTEM

For units with serial number greater than 13930, see 820639 - 820640 systems.

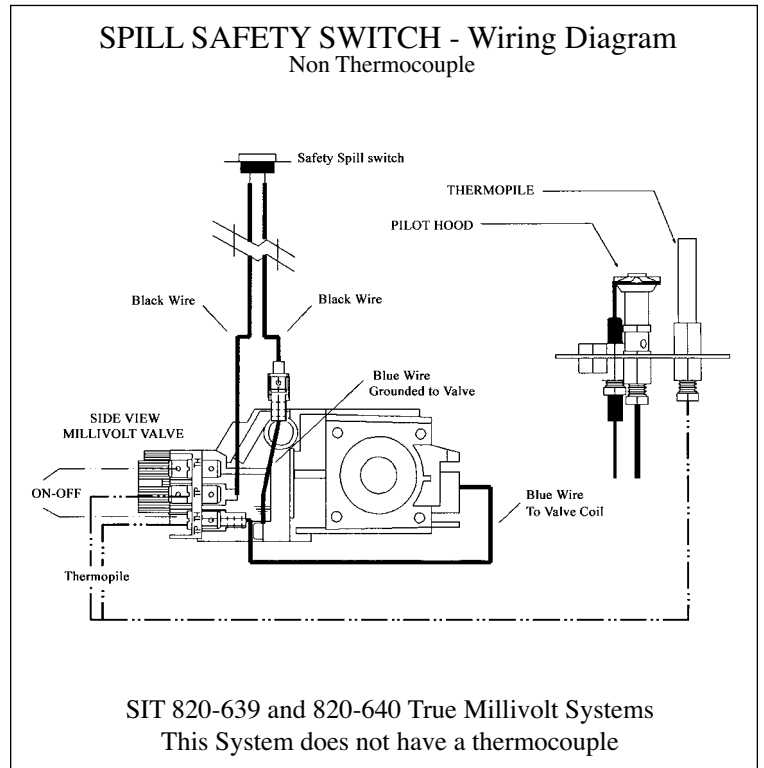
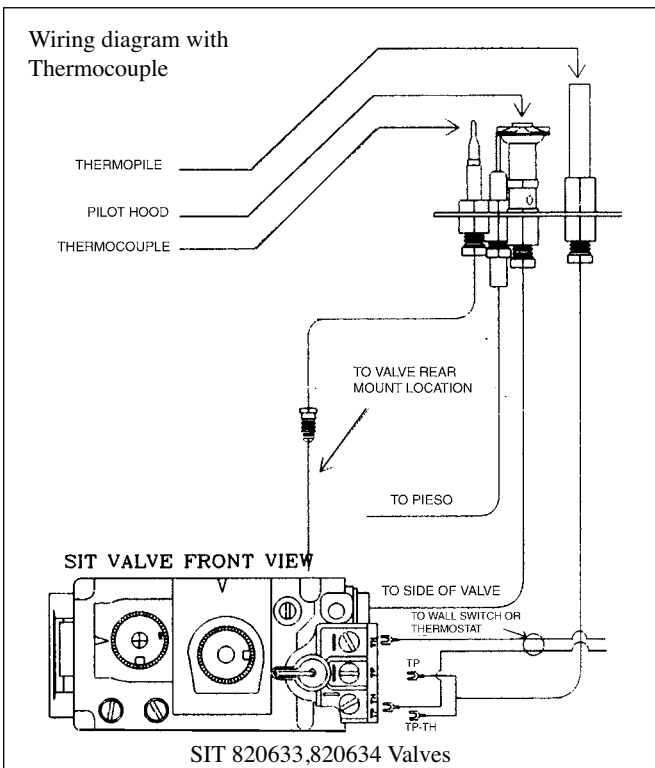
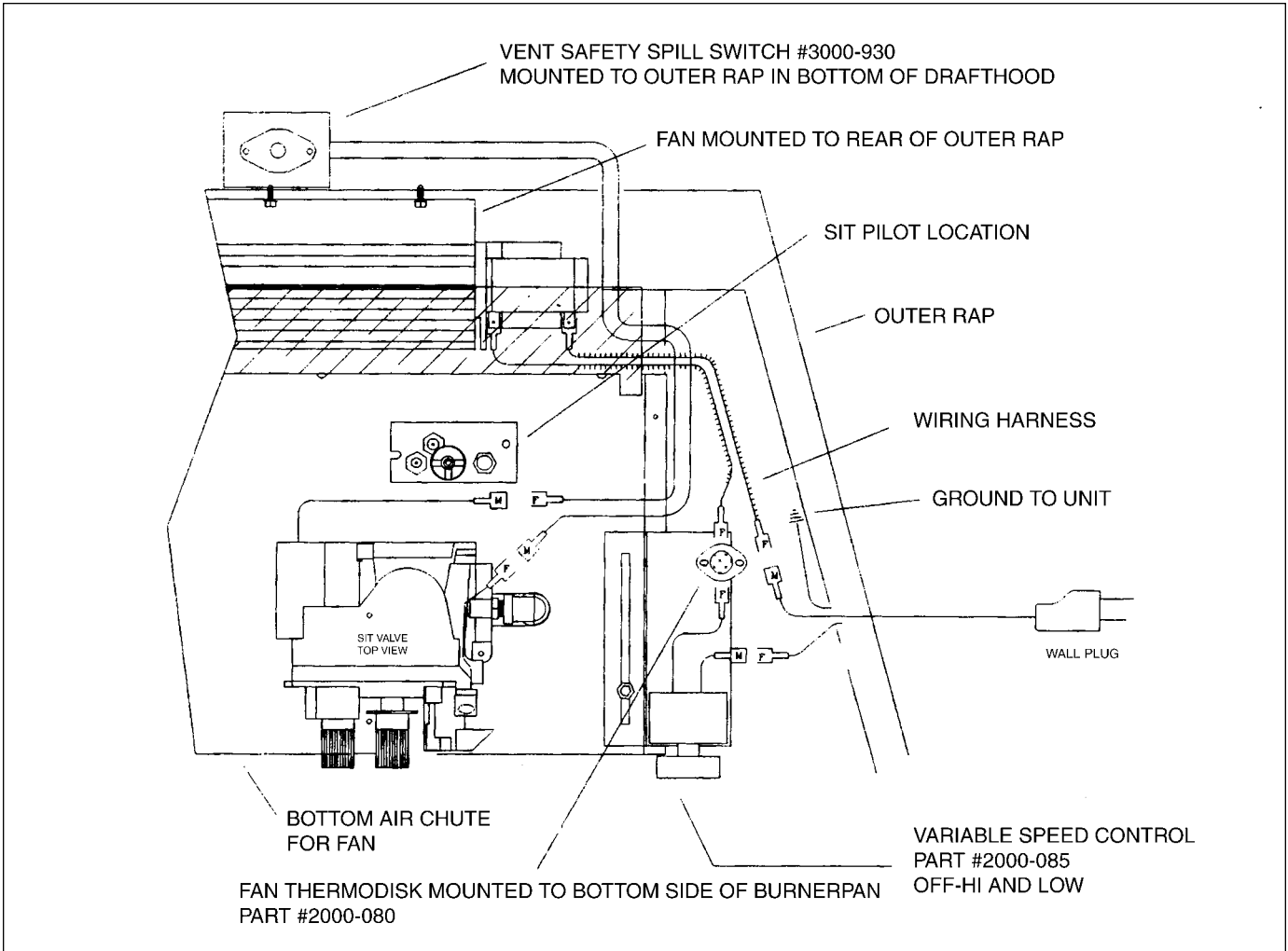

20. ACCESSORY LIST

<u>Part Number</u>	<u>Description</u>
Surround Kit and Trim Kit - Three Piece (Required for each Insert)	
V25S2436B	Surround Deluxe - Black VFI25
V25T2436A	Trim Kit - Antique Brass
V25T2436C	Trim Kit - Chrome
V25T2436P	Trim Kit - Polish Brass (Size 24 13/16" High x 36 3/16" Wide)
V25S2640B	Surround Large Deluxe - Black VFI25
V25T2640A	Trim Kit - Antique Brass
V25T2640C	Trim Kit - Chrome
V25T2640P	Trim Kit - Polish Brass (Size 26 13/16" High x 40 3/16" Wide)
V2R2436	Riser For Deluxe Surround (2 1/2") - For Use on V25S2436B
V2R2640	Riser For Deluxe Surround (2 1/2") - For Use on V30S2640B & V25S2640B
V25S2129B	Surround Kit Flat - Black
V25T2129A	Trim Kit - Antique Brass
V25T2129C	Trim Kit - Chrome
V25T2129P	Trim Kit - Polish Brass (Size 21" High x 29" Wide)
V25S2738B	Surround Kit Large Flat - Black
V25T2738A	Trim Kit - Antique Brass
V25T2738C	Trim Kit - Chrome
V25T2738P	Trim Kit - Polish Brass (Size 27" High x 38 3/4" Wide)
Surround Kit and Trim Kit - Four Piece (Required for each Insert)	
V25PF2637B	Surround Picture Frame Four Piece - Black
V25TP2637A	Trim Kit - Antique Brass
V25TP2637C	Trim Kit - Chrome
V25TP2637P	Trim Kit - Polish Brass (Size 26 1/2" High x 37" Wide)
V25PF3838B	Surround Picture Frame Large Four Piece - Black
V25TP3838A	Trim Kit - Antique Brass
V25TP3838C	Trim Kit - Chrome
V25TP3838P	Trim Kit - Polish Brass (Size 38 5/8" High x 38 5/8" Wide)
Grill Kit (Required for each Insert)	
VI20GBL	Grill Kit - Black
VI20GAB	Grill Kit - Antique Brass
VI20GPB	Grill Kit - Polish Brass
VI20GCR	Grill Kit - Chrome

Log Sets (Required for each Insert)

LOGC5	Log Set - Four Piece Cast Split Oak
LOGF5	Log Set - Four Piece Fibre Split Oak
LOGC6	Log Set - Four Piece Cast Split Oak c/w Glowing Ember Rocks

Optional Accessories

V25P2738A	Panel Large Kit - Antique Brass (For use on V25S2738B)
V25P2738C	Panel Large Kit - Chrome (For use on V25S2738B)
V25P2738P	Panel Large Kit - Polish Brass (For use on V25S2738B)
V25P2637A	Panel Picture Frame Kit - Antique Brass (For use on V25PF2637B)
V25P2637C	Panel Picture Frame Kit - Chrome (For use on V25PF2637B)
V25P2637P	Panel Picture Frame Kit - Polish Brass (For use on V25PF2637B)

(Note Panel Kits are not available for Deluxe Surrounds)

V25ADDX	Arch Door Frame - Deluxe Black (352)
V25ADTH	Arch Door Frame - Top Half Black (353T)
V25ADDA	Arch Door Frame - Double Arch Black (354)
V25ADDD	Arch Door Frame - Double Door Arch Black (355)
V25ADBL	Arch Door Frame - Black (351)

ZIMT	Thermostat Millivolt Wall Mount
Z80PT	Thermostat Programmable Digital Millivolt Wall Mount (1F80-40)
ZIRC	Remote Control Millivolt (On/Off with LED) (Model I)
ZART	Remote Control Thermostat Millivolt (Model K)
DCHS	Remote Control Heatshield

Venting Accessories

VI4SK25	Chimney Liner Starter kit - (4" Diameter x 25') Kit Includes: Aluminum Liner 25ft. , Chimney Flashing, Rain Cap, Mortar Collar, Screws
ZDV4FP8	Flex Pipe 4" Diameter (4' Unexpanded to 8' Expanded)
ZDV4FP20	Flex Pipe 4" Diameter (10' Unexpanded to 20' Expanded)
ZDV4FC	Flex Connector 4" Diameter

21. REPLACEMENT PARTS FOR VFI25

Valve System Parts - S.I. T . SYSTEM #1 Old SIT System (If Serial Number is LESS than 25727)

<u>Part Number</u>	<u>Description</u>
1000-P136WR	Thermopile GOAI-524
1001-P035SI	Electrode Sparker 915.035 SIT
1001-P129SI	Thermocouple 290.129 SIT unified
1001-P157SI	Orifice Pilot LP 977.157 SIT
1001-P159SI	Orifice Pilot NG 977.159 SIT
1001-P508SI	HT Cable 16
1001-P633SI	Valve Nova LP Hi/Lo 0820633
1001-P634SI	Valve Nova NG Hi/Lo 0820634
1001-P605SI	Pilot Burner LP 190.605 unified SIT
1001-P606SI	Pilot Burner NG 190.606 unified SIT

Valve System Parts - S.I. T . SYSTEM #2 New Top Convertible SIT system
(If Serial Number is BETWEEN than 25727-25901)

<u>Part Number</u>	<u>Description</u>
1000-P136WR	Thermopile GOAI-524
1001-P069SI	Electrode Sparker 915.069 TC SIT
1001-P216SI	Thermocouple 290.216 TC SIT
1001-P165SI	Orifice Pilot NG 977.165 TC SIT
1001-P167SI	Orifice Pilot LP 977.167 TC SIT
1001-P508SI	HT Cable 16
1001-P633SI	Valve Nova LP Hi/Lo 0820633
1001-P634SI	Valve Nova NG Hi/Lo 0820634
1001-P713SI	Pilot Burner LP 199.713 TC SIT
1001-P714SI	Pilot Burner NG 199.714 TC SIT

Valve System Parts - S.I. T . SYSTEM #3 New SIT TC True Millivolt Vented only
(If Serial Number is equal to or GREATER than 25908)

<u>Part Number</u>	<u>Description</u>
1000-P136WR	Thermopile GOAI-524
1001-P069SI	Electrode Sparker 915.069 TC SIT
1001-P165SI	Orifice Pilot NG 977.165 TC SIT
1001-P167SI	Orifice Pilot LP 977.167 TC SIT
1001-P639SI	Valve Nova LP Hi/Lo 0820639 True MV
1001-P640SI	Valve Nova NG Hi/Lo 0820640 True MV
1001-P745SI	Pilot Burner LP 199.745 TC TM
1001-P746SI	Pilot Burner NG 199.746 TC TM

Miscellaneous Parts

1000-EMBER	Glowing Ember and Rock Kit
1000-214	Piezo-Ignitor
1000-216	On/Off Switch - for Burner
1000-255-40	Orifice Burner NG #40 (0 - 4500 ft)
1000-255-52	Orifice Burner LP #52 (0 - 4500 ft)
2000-080	Thermodisk - for Automatic on/off Fan
2000-081	Fan Motor
2000-085	Variable Speed Control
2000-032F	Draft Hood (Assembly)
2000-079	Gasket for Flue
2500-BNGSI	Burner Assy - c/w Valve - Natural Gas
2500-BLPSI	Burner Assy - c/w Valve - Liquid Propane
3000-930	Spill Safety Switch (36T21)
3000-940	Glass Robax (23.22 x 11.75)
3000-956	Gasket (14 x 3/8 x 1/8)
3000-957	Gasket (19-1/2 x 1/2)
3000-958	Gasket (1-5/8 x 1/2)
3000-959	Thermalcord (for Door)
C30-GEK	Grate & Ember Plate kit for C6 Log Set Field Conversion c/w Ember Plates & Grate Bars (4 each) (VFI25, VFI30)

Conversion Kit (SIT Valve only)

25VFI-CKLP	LP Conversion Kit
25VFI-CKNG	NG Conversion Kit

22. MILLIVOLT LIGHTING INSTRUCTIONS

FOR YOUR SAFETY READ BEFORE LIGHTING

WARNING: If you do not follow these instructions exactly, a fire or explosion may result causing property damage, personal injury or loss of life.

BEFORE LIGHTING

- A** This appliance has a pilot which must be lighted by hand. When lighting the pilot, follow these instructions exactly.
- B** Smell all around the appliance area for gas. Be sure to smell next to the floor because some gas is heavier than air and will settle on the floor.
- WHAT TO DO IF YOU SMELL GAS**
- Do not try to light an appliance.
 - Do not touch any electrical switch; do not use any phone in your building.
 - Immediately call your gas supplier from a neighbour's phone. Follow the gas supplier's instructions.
- If you cannot reach your gas supplier, call the fire department.
- C** Use only your hand to push or turn the gas control knob. Never use tools. If the knob will not push in or turn by hand, don't try to repair it, call a qualified technician. Force or attempted repair may result in a fire or explosion.
- D** Do not use this appliance if any part has been under water. Immediately call a qualified service technician to inspect the appliance and to replace any part of the control system which has been under water.

LIGHTING INSTRUCTIONS

1. Stop! Read the safety information above on this label.
2. Set the thermostat to lowest setting.
3. Turn off all electrical power to the appliance.
4. Locate valve under the burner assembly.
5. If the control knob is not already in the off position, ie. the word "OFF" in the 1 o'clock position, then push in the gas control knob slightly and turn clockwise to "OFF".
NOTE: Knob cannot be turned from "PILOT" to "OFF" unless knob is pushed in slightly. Do not use force.
6. Wait five (5) minutes to clear out any gas. If you then smell gas. STOP! Follow "B" in the safety information above on this label. If you don't smell gas then go to the next step.
7. Now push in the control knob slightly and turn counter-clockwise to the "PILOT" position.
8. Push in the control knob all the way and hold it. With the other hand push in the red igniter button until you hear a click. Now observe closely the pilot burner located on the rear center-left hand side of the main burner. If a flame has appeared then continue to depress the control knob for 20 seconds. If the flame did not appear then continue to depress the red igniter button every 5 seconds until a flame is established. NOTE: If after 30 seconds a flame has not yet been established then turn the control knob back to the off position and repeat steps 5, 6 & 7.
9. Once the pilot has been established hold the control knob in the depressed position for approximately 25 seconds before releasing. If the flame goes out then repeat steps 7 and 8.
10. Now turn the control knob to the "ON" position. The burner will not light unless the wall switch thermostat or remote control is turned "ON" or in the case of the thermostat there is a call for heat.
11. Close the access door and turn all electric power back to the appliance.

TO TURN OFF THE APPLIANCE

1. Set the thermostat to lowest setting.
2. Turn off all electric power to the appliance if service is to be performed.
3. Open the control access door.
4. Push in the gas control knob slightly and turn clockwise to the "OFF" position. Do not force.
5. Replace control access panel.

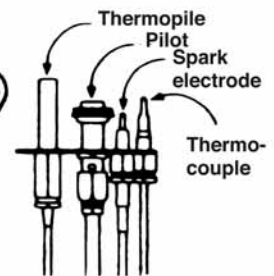
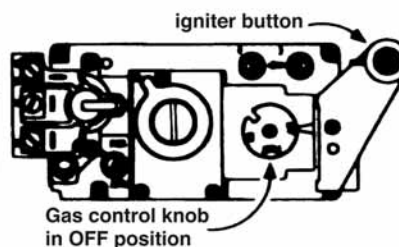
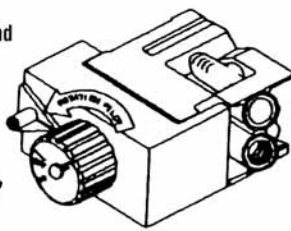



LIMITED LIFETIME WARRANTY

This Limited Lifetime Warranty applies only while the unit remains at the site of the original installation and only if the unit is installed inside the continental United States, Alaska, Hawaii, and Canada. The warranty applies only if the unit is installed and operated in accordance with the printed instructions and in compliance with applicable installation and building codes and good trade practices.

BASIC ONE YEAR WARRANTY

During the first year after installation, we will provide a replacement for any component part of your unit found to be defective in materials or workmanship, including labour costs. Repair work requires prior approval by Kingsman, labour costs are based on a predetermined rate schedule and any repair work must be done through an authorized Kingsman dealer.

LIMITED LIFETIME WARRANTY

The heat exchanger, combustion chamber and burner of every Kingsman product excluding the Outdoor Firepit are warranted against materials or workmanship during the period the product is owned by the original owner. The part to be replaced must be returned to our distributor in exchange for the replacement part. Any labor, material, freight and/or handling charges associated with any repair or replacement pursuant to this Limited Lifetime Warranty will not be covered by this warranty.

GENERAL TERMS

In lieu of providing a replacement part, we may, at our option, provide the distributor's component purchase price from us or a credit equal to the distributors component purchase price from us toward the purchase of any new unit which we distribute. If a credit is given in lieu of a replacement part, the rating plate from the unit being replaced must be submitted on a warranty claim, and the unit being replaced must be made available to our distributor for disposition.

In establishing the date of installation for any purpose, including determination of the starting date for the term of this Limited Lifetime Warranty, reasonable proof of the original installation date must be presented*, otherwise the effective date will be based upon the date of manufacture plus thirty (30) days.

We will not be responsible for and you, the user, will pay for: (a) damages caused by accident, abuse, negligence, misuse, riot, fire, flood, or Acts of God (b) damages caused by operating the unit where there is a corrosive atmosphere containing chlorine, fluorine, or any other damaging chemicals (other than in a normal residential environment) (c) damages caused by any unauthorized alteration or repair of the unit affecting its stability or performance (d) damages caused by improper matching or application of the unit or the unit's components (e) damages caused by failing to provide proper maintenance and service to the unit (f) any expenses incurred for erecting, disconnecting or dismantling the unit (g) parts or supplies used in connection with service or maintenance (h) damage repairs, inoperation or inefficiency resulting from faulty installation or application (i) electricity or fuel costs or any increase in electricity or fuel cost whatsoever including additional or unusual use of supplemental electric heat.

We shall not be liable for any incidental, consequential, or special damages or expenses in connection with any use or failure of this unit. We have not made and do not make any representation or warranty of fitness for a particular use or purpose, and there is no implied condition of fitness for a particular use or purpose. We make no express warranties except as stated in this Limited Lifetime Warranty. No one is authorized to change this Limited Lifetime Warranty or to create for us any other obligation or liability in connections with this unit. Any implied warranties shall last for one year after the original installation. Some states and provinces do not allow the exclusion or limitation of incidental or consequential damages or do not allow limitations on how long an implied warranty or condition lasts, so the above limitations or exclusions may not apply to you. The provisions of this limited warranty are in additions to and not a modification of or subtraction from any statutory warranties and other rights and remedies provided by law.

Save this certificate. It gives you specific legal rights, and you may also have other rights which may vary from state to state and province to province.

In the event your unit needs servicing, contact your dealer or contractor who installed or serviced your unit. When requesting service, please have the model and serial number from each unit readily available. If your dealer needs assistance, the distributor is available for support and we, in turn support the distributor's efforts.

Fill in the installation date and model and serial numbers of the unit in the space provided below and retain this limited warranty for your files.

Model No. _____ Serial No. _____ Date installed _____

Dealer or Contractor Name: _____

*To receive advantage of your warranty, you must retain the original records that can establish the installation date of your unit.